



20 Litre Silver Digital Microwave

Instruction Manual



Model Number: RHM2017

**Please read these instructions carefully and
keep them for future reference**

For Customer Services & Spare Parts please call

0845 209 7461

Opening times: Monday – Friday

8am – 6pm

MICROWAVE OVEN

User Instructions – Please keep for future reference

Model: RHM2017

Read these instructions carefully before using your microwave oven. By following these instructions carefully your oven will provide you with many years of excellent service.

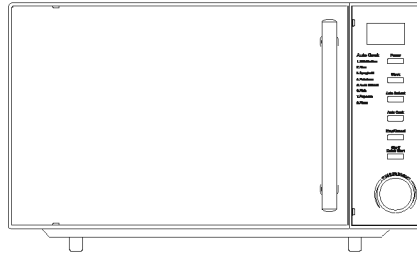

Specifications	
Model:	RHM2017
Power Source:	230V~240V/50Hz
Microwave Power Consumption:	1200 Watt
Microwave Maximum Output:	800 Watt
Oven Capacity:	20 litres
Turntable Diameter:	Ø 245 mm
External Dimensions (L x W x H):	262×452×395mm
Net Weight:	Approx. 12Kg

IMPORTANT

- **WARNING:** if the door or door seals are damaged, the oven must not be operated until it has been repaired by a competent person.
- **WARNING:** it is hazardous for anyone other than a competent person to carry out any service or repair operation that involves the removal of a cover which gives protection against exposure to microwave energy;
- **WARNING:** liquids and other food must not be heated in a sealed container since they are liable to explode;
- **WARNING:** only allow children to use the oven without supervision when adequate instruction have been given so that the child is able to use the oven in a safe way and understands the hazards of improper use.
- **WARNING:** accessible parts may become hot during use. Young children should be kept away.

CAREFULLY RETAIN THESE INSTRUCTIONS

For Customer Services & Spare Parts please call **0845 209 7461** Opening times: Monday – Friday 8am – 6pm

SAFETY INSTRUCTIONS

1. The oven must be placed on a level surface.
2. The turntable and turntable ring assembly must always be used in the oven during cooking. Place the cookware gently on the turntable and handle it carefully to avoid possible breakage.
3. Incorrect use of dish for browning food may cause turntable to break.
4. Use only the specified bag size when using pre-prepared popcorn.
5. The oven has several built-in safety switches to ensure that the power remains off when the door is open. Do not tamper with these switches.
6. Do not operate the microwave oven when empty. Operating the oven with no food or food that is extremely low in moisture can cause fire, charring or sparking.
7. Do not cook bacon directly on the turntable. Excessive local heating of the turntable may cause the turntable to break.
8. Do not heat baby bottles or baby food in the microwave oven. Uneven heating may occur which could cause scalding when feeding the baby.
9. Do not heat narrow-necked containers, such as syrup or sauce bottles.
10. Do not attempt to deep-fry in your microwave oven.
11. Do not attempt home canning in this microwave oven as it is impossible to be sure all contents of the jar have reached boiling temperature.
12. Do not use this microwave oven for commercial purpose. This microwave oven is made for household use only.
13. To prevent delayed eruptive boiling of hot liquids and beverages or scalding yourself, stir liquid before placing the container in the oven and during heating.
14. Check the food in the microwave oven frequently to avoid burning due to overheating.
15. Failures to maintain the oven in a clean condition could lead to deterioration of the surface which could adversely affect the life of appliance and possibly result in a hazardous situations.
16. Stand at arm's length when opening the door to avoid scalding when steam or hot air is released.
17. ALWAYS allow an appropriate standing time after the oven has switched off according to the food being cooked to allow heat to distribute evenly throughout the food.
18. Use oven gloves when removing any cookware from oven to reduce chance of being burned or scalded.
19. Read and follow the specific: "recautions for avoiding possible exposure to excessive microwave energy".
20. As with most cooking appliances, close supervision is necessary to reduce the risk of a fire in the oven cavity. If a fire should start or smoke is observed:
 - a. Keep the oven door closed.
 - b. Turn the oven off and unplug the appliance.
21. Eggs in their shell and whole hard-boiled eggs should not be heated in microwave ovens since they may explode.
22. Do not overcook food. Regularly observe the oven if paper, plastic, or other combustible materials are used in the oven.
23. Do not use the oven cavity for storage purposes. Do not store items such as bread, cookies, paper products, etc. inside the oven.
24. Remove wire twist-ties and metal handles from paper or plastic containers/bags before placing them in the oven.
25. This oven must be earthed. Connect only to properly earthed outlet. See "earthing installation".
26. Install or locate this oven in accordance with the installation instructions provided.
27. Use this appliance only for its intended uses as described in the manual. Do not use corrosive chemicals or vapours in this appliance. This

Oven is specifically designed to heat or cook food. It is not designed for industrial or laboratory use.

28. Never allow children to use the oven without supervision unless adequate instructions have been given so that the children are able to use the oven in a safe way and understand the hazards of improper use.
29. If the supply cord or plug is damaged, or if the oven is not working properly or has been dropped it must be replaced or repaired by the manufacturer or its service agent or a similarly qualified person in order to avoid a hazard.
30. This appliance should be serviced only by qualified service technicians. Contact the nearest authorised service facility for examination, repair or adjustment.
31. Do not cover or block any vents on the oven.
32. Do not store or use this appliance outdoors.
33. Do not use this oven near water, near a kitchen sink, in a wet basement or near a swimming pool.
34. Do not immerse cord or plug in water.
35. Keep cord away from heated surfaces.
36. Do not let cord hang over edge of table or counter.
37. When cleaning door and oven surfaces use only mild, non-abrasive soaps or detergents applied with a sponge or soft cloth.
38. There must be more than 30cm free or open space above the top surface of the oven.
39. Do not attempt to repair the oven yourself, please consult an authorised service agent.
40. The contents of feeding bottles and baby food jars are to be stirred or shaken and the temperature should be carefully checked before consumption, in order to avoid burns.
41. Do not attempt to operate this oven with the door open since open-door operation can result in harmful exposure to microwave energy. It is important not to try and override or tamper with the safety interlocks.
42. Do not operate the oven if it is damaged. It is particularly important that the oven door closes properly and that there is no damage to the, (1) door (i.e. door is not bent or dented), (2) hinges and latches (broken or loosened), (3) door seals and sealing surfaces.
43. Utensils should be checked to ensure that they are suitable for use in microwave ovens.
44. The symbol  on the product or on its packaging indicates that this product may not be treated as household waste. Instead it shall be handed over to the applicable collection point for the recycling of electrical and electronic equipment. By ensuring this product is disposed of correctly, you will help prevent potential negative consequences for the environment and human health, which could otherwise be caused by inappropriate waste handling of this product. For more detailed information about recycling of this product, please contact your local city office, your household waste disposal service or the shop where you purchased the product.
45. The lampholder is installed in the oven that is non-user serviceable area.
46. The oven should be cleaned regularly and any food deposits removed.
47. Do not use harsh abrasive cleaners or sharp metal scrapers to clean the oven door glass since they can scratch the surface, which may result in shattering of the glass.
48. Do not use steam cleaners inside the cavity.
49. During use the appliance becomes hot. Care should be taken to avoid touching heating elements inside the oven.
50. This appliance is not intended for use by persons (including children) with reduced physical, sensory or mental capabilities, or lack of experience and knowledge, unless they have been given supervision or instruction concerning use of the appliance by a person responsible for their safety.
51. Microwave heating of beverages can result in delayed eruptive boiling, therefore care must be taken when handling the container.

For Customer Services & Spare Parts please call **0845 209 7461** Opening times: Monday – Friday 8am – 6pm

CONTENTS

	PAGE
Specifications	1
Safety Instructions	2
Contents	4
Materials You Can Use In Microwave Oven	5
Materials To Avoid Using In Microwave Oven	5
Utensils	6
Oven Components And Accessories	6
Turntable Installation	7
Installing Your Oven	7
Microwave Cooking Principles	8
Microwave Food Packaging Symbols	8
Operating Your Microwave Oven	9
Control Panel	9
Setting the Clock	10
Microwave Cooking	10
Auto Defrost	11
Auto Cook	12
Quick Start	13
Child Lock	13
Warming Up and Heating	13
Cleaning Your Microwave Oven	14
Troubleshooting and Maintenance	15
Questions and Answers	16
Important Notes	17
Earthing Installation	18

For Customer Services & Spare Parts please call **0845 209 7461** Opening times: Monday – Friday 8am – 6pm

MATERIAL YOU CAN USE IN MICROWAVE OVEN

Utensils	Remarks
Aluminum foil	Shielding only. Small smooth pieces can be used to cover thin parts of meat or poultry to prevent overcooking
Arcing can occur if foil is too close to oven walls.	The foil should be at least 1 inch (2.5cm) away from oven walls.
Browning dish	Follow manufacturer's instructions. The bottom of browning dish must be at least 3/16 inch (5mm) above the turntable. Incorrect usage cause the turntable to break
Dinnerware	Microwave-safe only. Follow manufacturer's instructions. Do not use cracked or chipped dishes.
Glass jars	Always remove lid. Use only to heat food until just warm. Most glass jars are not heat resistant and may break
Glassware	Heat-resistant oven glassware only. Make sure there is no metallic trim. Do not use cracked or chipped dishes.
Oven cooking bags	Follow manufacturer's instructions. Do not close with metal tie. Make slits to allow steam to escape.
Paper plates and cups	Use for short-term cooking/warming only. Do not leave oven unattended while cooking.
Paper towels	Use to cover food for reheating and absorbing fat. Use with supervision for short-term cooking only.
Parchment paper	Use as a cover to prevent splattering and retain moisture
Plastic	Microwave-safe only. Follow the manufacturer's instructions. Should be labelled "Microwave Safe". Some plastic containers soften as the food inside gets hot. "Boiling bags" and tightly closed plastic bags should be slit, pierced or vented as directed by package.
Plastic wrap	Microwave-safe only. Use to cover food during cooking to retain moisture. Do not allow plastic wrap to touch food.
Thermometers	Microwave-safe only (meat and sugar thermometers)
Wax paper	Use as a cover to prevent splattering or as a wrap during steaming.

MATERIALS TO AVOID USING IN THE MICROWAVE OVEN

Utensils	Remarks
Aluminum tray	May cause arcing. Transfer food into microwave-safe dish.
Food carton with metal handle	May cause arcing. Transfer food into microwave-safe dish.
Metal or metal-trimmed utensils	Metal shields the food from microwave energy. Metal trim may cause arcing.
Metal twist ties	May cause arcing and could cause a fire in the oven.
Paper bags	May cause a fire in the oven
Plastic foam	Expanded polystyrene may melt or contaminate the liquid inside when exposed to high temperature.
Wood	Wood will dry out when used in the microwave oven and may split or crack.

UTENSILS

CAUTION

Personal Injury Hazard

Tightly-closed containers could explode. Closed containers should be opened and plastic pouches pierced before cooking. See above for further instructions "Materials you can use in microwave oven or to be avoided in microwave oven." There may be certain non-metallic utensils that are not safe to use for microwaving. If in doubt, you can test the utensil in question by following the procedure below.

Utensil test:

1. Fill a microwave-safe container with 1 cup of cold water (250ml) along with the utensil in question.
2. Cook on maximum power for 1 minute.
3. Carefully feel the utensil. If the utensil is warm, do not use it for microwave cooking.
4. Do not exceed 1 minute cooking time.

SETTING UP YOUR OVEN

OVEN COMPONENTS AND ACCESSORIES

Remove the oven and all the material from the carton. Your oven comes with the following accessories:

Glass plate - 1

Instruction manual - 1

Turntable ring assembly - 1

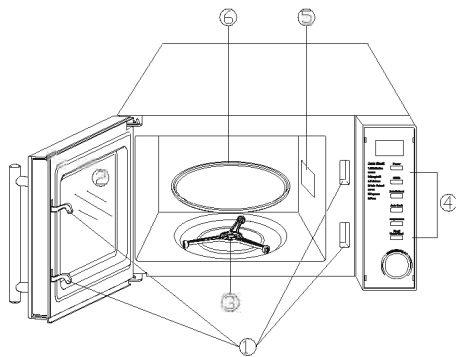

1. Door Safety Lock System
2. Oven Window
3. Turntable Ring Assembly
4. Control Panel
5. Wave Guide
6. Glass Turntable

For Customer Services & Spare Parts please call **0845 209 7461** Opening times: Monday – Friday 8am – 6pm

TURNTABLE INSTALLATION

Glass turntable(6), to be placed on the turntable support ring

- a. Never place the glass turntable (6) upside down. The turntable should never be restricted in movement.
- b. Both glass turntable (6) and turntable support ring (3) must always be used during cooking.
- c. All food and containers of food should always be placed on the glass turntable for cooking.
- d. The glass turntable rotates clockwise or anti-clockwise randomly, this is normal.
- e. If glass turntable or turntable support ring cracks or breaks, contact your nearest authorized service centre.

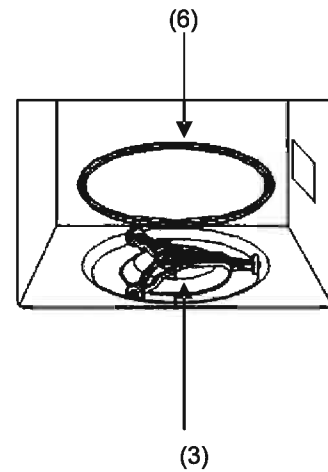

INSTALLING YOUR OVEN

Carefully remove all packaging materials and accessories.

Examine the oven for any damage such as dents or broken door.

Do not install if oven is damaged in any way.

Cabinet : Remove any protective film found on the outer surface.

Do not remove the light brown mica cover that is screwed onto the inner side of the microwave to protect the magnetron.

INSTALLATION

1. Select a level surface that provides enough clear space for the intake and / or outlet vents (see fig.3).

A minimum clearance of 3.0 inch (7.5cm) is required between the oven and any adjacent wall. One side must be clear.

1. Leave a minimum clearance of 12 inch (330) above the oven.
2. Do not remove the feet from the bottom of the oven.
3. Blocking the inside and/or outlet openings can damage the oven.

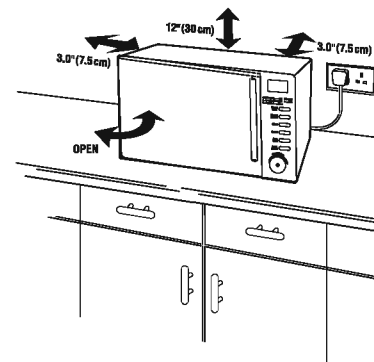

4. Place the oven as far away from radios and televisions as possible. Operation of microwave oven may cause interference to your radios and televisions as possible.
Operation of microwave oven may cause interference to your radio or televisions reception.
5. Plug your oven into a standard household outlet. Be sure the voltage and the frequency is the same as the voltage and the frequency on the rating label.
- Warning : Do not install microwave oven over a range cooktop or other heat-producing appliance. If installed above a heat producing appliance the microwave oven could be damaged and the warranty would be void.
- Warning : Do not install microwave oven in a cupboard.

MICROWAVE COOKING PRINCLIPES

1. The microwaves generated by the magnetron are evenly distributed through the food as the glass turntable revolves. This ensures that the food is cooked uniformly.
2. The microwaves are absorbed by the food up to a depth of approximately 1 inch (2.5cm). Cooking continues as the heat is dissipated through the food.
3. Cooking times will vary according to the recipe and the density, weight and water content of the food. The cooking time will also vary according to the temperature at the start of cooking, i.e. depending on whether the food is frozen or not.

MICROWAVE FOOD PACKAGING SYMBOLS

Microwave Symbols

On the front of your oven there is a microwave symbol, show as below. This symbol has been introduce for your benefit when cooking or reheating packing food.

Package food is also increasingly using a microwave symbol similar to the one below.

When you see this symbol on food packaging the cooking instructions are based on the either IEC power Output Rating. On the reheating Categories A, B, C, D or E

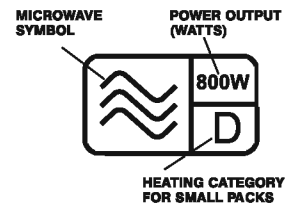

A, B, C, D or E

MORE HEATING TIME

LESS HEATING TIME

OPERATING YOUR MICROWAVE OVEN

CONTROL PANEL

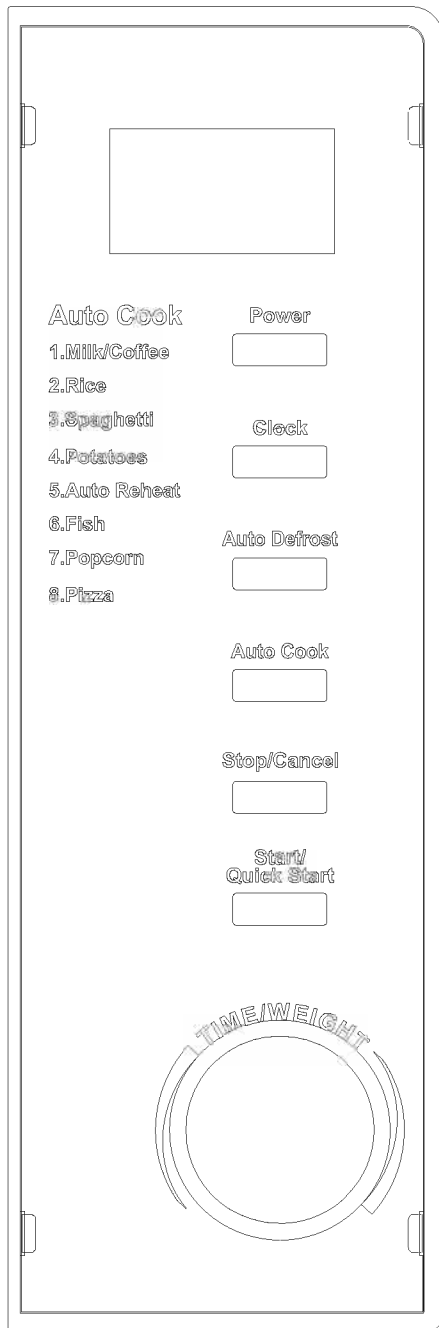

● Menu action screen

Cooking time, power, action indicators, and clock time are displayed.

POWER

Touch this button a number of times to set microwave cooking power level.

AUTO COOK

Press for instant settings to cook popular food,

AUTO DEFROST

Touch to defrost food by weight.

CLOCK

Touch this button to start setting the oven clock and ending by touching it again.

TIME/WEIGHT

Turn the dial to enter the oven clock time or input cooking time.

Rotate to specify food weight or number of servings

START/QUICK START

Touch to start a cooking program.

Simply touch it a number of times to begin express cooking without previously setting power level and cooking time.

STOP/CANCEL





Press to cancel setting or reset the oven before setting a cooking program.

Press once to temporarily stop cooking, or twice to cancel cooking altogether.











It is also used for setting child lock.

SETTING THE CLOCK

Your microwave Oven is equipped with a clock, you must set the clock when you first install your oven or after a power failure.

1. In standby mode, press  button repeatedly to set the clock in 12 or 24 hour cycle.
2. Turn  to indicate the hour digit.
3. Press  once.
4. Turn  to adjust the minute.
5. Finally, press  and the time will be set.









For example: Set the current time to 8:30 at 24H clock.

1. Press  once and it will display "12H" and  is flashing.
2. Press  again and it will display "24H" and  is flashing.
3. Turn  to adjust the hour until it displays 8:00 and  will flash.
4. Press  again, it displays "8:00",  is flashing.
5. Turn  to adjust the minute until it displays 8:30 and  will flash.
6. Press  once to confirm the setting and ":" is flashing.







Note: You can press the  button once to check clock time during cooking.

MICROWAVE COOKING

To cook with microwave, time and power level should be set. The longest cooking time to be set by touching the number pads is 60 min.











1. Press  to select the microwave cooking and the display shows "100", , , & .
2. Continue to press  to select the required microwave power level until the required power setting is reached.
3. Turn  to adjust the cooking time until the required time is reached and  is flashing.
4. Press  to start the cooking.

Example: Setting cooking time of 20 minutes on power 80%

1. Press  button twice and the display shows 80, , , & .
2. Turn  clockwise to adjust the cooking time to 20:00 and  is flashing.
3. Press  to start cooking.

When the cooking is finished, the oven will display END and beep every two minutes until the oven door is opened or Stop/Cancel button is pressed.







Microwave power chart

No. of time to press  Button	Microwave Power Level	Display
1 time	100%	"100,  % 
2 times	80%	" 80,  % 
3 times	60%	" 60,  % 
4 times	40%	" 40,  % 
5 times	20%	" 20,  % 







Always remember that cooking instructions are intended only as a guide. If you have followed the instructions and the food is still not piping hot throughout, simply return it to the oven and cook it until it is.

AUTO DEFROST

The oven allows the defrosting food based on the weight you entered. The time and the defrosting power are adjusted automatically once the weight is programmed. The food weights range from 100g to 1800g.

- Press the  once and the LED displays " 1 00", , "AUTO",  and  is flashing.
- Turn the  to select the weight of food.
- Press  to start the cooking.

EXAMPLE: To defrost 600g of shrimp.

- Press the  left until LED display "1 00" & . And "AUTO",  &  are flashing.
- Turn the  until the LED displays 600g.
- Press  to start the cooking.

Note: The max weight for defrost input is 1800g.

Defrost time and Power for different weight food chart.

Input weight	Cooking time	Power		
		Stage 1	Stage 2	Stage 3
100	5:00	40%	20%	20%
200	7:00	40%	20%	20%
300	9:00	40%	20%	20%
400	11:00	40%	20%	20%
500	13:00	40%	20%	20%
600	15:00	40%	20%	20%
700	17:00	40%	20%	20%
800	19:00	40%	20%	20%
900	21:00	40%	20%	20%
1000	23:00	40%	20%	20%
1100	25:00	40%	20%	20%
1200	27:00	40%	20%	20%
1300	29:00	40%	20%	20%
1400	31:00	40%	20%	20%

For Customer Services & Spare Parts please call 0845 209 7461 Opening times: Monday – Friday 8am – 6pm

1500	33:00	40%	20%	20%
1600	35:00	40%	20%	20%
1700	37:00	40%	20%	20%
1800	39:00	40%	20%	20%



Note: The cooking time for each stage is 1/3 of total cooking time.

Note: During defrosting process, the system will pause and signal to remind you to turn over the food, after that, press  to resume.







AUTO COOK

This auto function has eight pre-set cooking program. You do not need to set either cooking times or power level. The table below shown the details of the programs.

- In standby state, press  repeatedly to choose desire auto cooking program, i.e. 1 to 8.
- Turn  to select the weight of food.
- Press  to start the cooking.

Example: To cook 400g of fish.

- Press  continuously until the LED displays "AUTO" & "6".
- Continue to turn  until the LED display "400", , "AUTO" &  are flashing.
- Press  to start cooking.

AUTO FUNCTION COOKING CHART

Auto Cooking	Auto Manual	Weight	Display	Power
1	MILK/COFFEE	1 portion / 200 ml 2 portions / 400 ml 3 portions / 600 ml	1 2 3	P-100
2	RICE	150 g 300 g 450 g 600 g	150 g 300 g 450 g 600 g	Time:30% P-100 Time:70% P-40
3	SPAGHETTI	100 g 200 g 300 g	100 g 200 g 300 g	P-80
4	POTATO	1 portion / 230 g 2 portions / 460 g 3 portions / 690 g	1 2 3	P-100
5	AUTO REHEAT	200 g 300 g 400 g 500 g 600 g 700 g 800 g	200 g 300 g 400 g 500 g 600 g 700 g 800 g	P-100
6	FISH	200 g 300 g 400 g 500 g 600 g	200 g 300 g 400 g 500 g 600 g	P-80
7	POPCORN	99g	99g	P-100
8	PIZZA	150g 300g 450g	150g 300g 450g	P-100

Note:



- For milk/coffee and potato, parameters on display are not weight but number of servings.

For Customer Services & Spare Parts please call 0845 209 7461 Opening times: Monday – Friday 8am – 6pm



2. For popcorn, there is only one weight choice.
3. For Spaghetti add boiling water before cooking.

The result of auto cooking depends on factors such as fluctuation of voltage, the shape and size of food, your personal preference as to the doneness of certain foods and even how well you happen to place food in the oven. If you find the result at any rate not quite satisfactory, please adjust the cooking time a little bit accordingly.



QUICK START



In the standby mode, press the  button once, the oven will start to cook with 100% power for 30 sec. Each additional press on the  will increase the cooking time for another 30 sec, and the longest time for this setting can be added up to 12 minutes.

Example: To cook for 2 minutes with 100% power

Press  button 4 times the LED displays , ,  and the cooking time will increase to 2 minutes. The oven starts cooking immediately at full microwave power. Then  will disappear.

CHILD LOCK

Lock: In standby state, press  over 3 seconds, a "beep" will be heard denoting entering the children—lock state, and the lock indicator  will be illuminated.

Unlock: In locked state, press  over 3 seconds, a long "beep" will be heard denoting entering the lock is released, and the  locked indicator will disappear.

WARNING UP AND HEATING

Times stated are approximate and can vary depending on the quality, size of the chopped pieces, storage temperature and moisture content of the foodstuff. It is advisable to set a shorter cooking time at first, and then if necessary continue the cooking process, until the food is cooked to your satisfaction.

Foodstuff	Quantity	Output Level	Time (Mins)	Remarks
Liquids				
Milk, 1 cup	150g	P100 (=100%)	0.5 - 1	Caution: Stir the liquid prior to and during heating/reheating, let liquid stand for at least 10 seconds after cooking and always take care when adding ingredients to hot liquids.
Water/Coffee /Milk 1 cup	150g	P100 (=100%)	1 - 2	Caution: Stir the liquid prior to and during heating/reheating, let liquid stand for at least 10 seconds after cooking and always take care when adding ingredients to hot liquids.
Water	500g	P100 (=100%)	3 - 5	Caution: Stir the liquid prior to and during heating/reheating, let liquid stand for at least 10 seconds after cooking and always take care when adding ingredients to hot liquids.
One-course meals/ Ready-to-serve meals	450g	P100 (=100%)	4 - 6	Cover.
Soups	250g	P100 (=100%)	1 - 2	Stir.
Stews	500g	P100 (=100%)	3 - 5	Stir between times.
Meat / Poultry				
Roast	250g	P100 (=100%)	2 - 3	
Rissoles/Meatballs	500g	P100 (=100%)	3 - 4	

For Customer Services & Spare Parts please call **0845 209 7461** Opening times: Monday – Friday 8am – 6pm

1/2 Chicken	450g	P100 (=100%)	3 - 4	Lightly brush with oil.
Vegetables				
Portion x 1	150g	P100 (=100%)	1 - 2	Cover, stir.
Portions x 2	300g	P100 (=100%)	2 - 4	Cover, stir.
Side Dishes				
Noodles	150g	P100 (=100%)	1 - 2	Dampen slightly beforehand, cover, stir.
Rice	150g	P100 (=100%)	1 - 2	Dampen slightly beforehand, cover, stir.
Potatoes	500g	P100 (=100%)	3 - 4	Cover.
Baby Food	approx, 200g	P100 (=100%)	1 - 2	Stir well, check the temperature.
Meat				
Beef, Pork in one piece	500g	P 80 (= 70%)	11 - 14	Cover, turn halfway through cooking, leave to stand for 3-5 minutes.
Lightly smoked pork loin	500g	P 80 (= 70%)	12 - 15	
Meatloaf		P100 (=100%)	12 - 15	
Sausages	200g	P 80 (= 70%)	2 - 3	Pierce skin with fork.
Poultry				
Chicken	1000g	P100 (=100%)	20 - 25	Cover, turn once, leave to stand for 5 minutes.
Pieces of Chicken	250g	P 80 (=70%)	4 - 5	
Fish				
Fresh fish	300g	P 80 (= 70%)	5 - 7	Cover, turn once, leave to stand for 3 minutes.
Fillet of fish	300g	P 80 (= 70%)	4 - 5	Cover, turn once, leave to stand for 3 minutes.
Frozen fish	400g	P100 (=100%)	8 - 10	Cover, leave to stand for 3 minutes.
Vegetables, fresh				
Cauliflower, broccoli, fennel	150g	P100 (=100%)	8 - 10	Chop vegetables into small pieces, cook with liquid, (3-5 tablespoons), stir in between times leave to stand for 3-5 minutes, add spices, (salt before serving).
French beans	500g	P100 (=100%)	10 - 12	
Potatoes, boiled potatoes	500g	P100 (=100%)	8 - 10	
Jacket potatoes	500g	P100 (=100%)	10 - 12	Prick the jacket for boiling potatoes.
Carrots	500g	P100 (=100%)	8 - 10	
Vegetables, deep frozen				Take note of details on the packaging.
Leaf spinach	300g	P100 (=100%)	10 - 12	Cover, add some liquid, stir in between times, leave to stand for 3 - 5 minutes.
Peas	300g	P100 (=100%)	7 -9	
Leeks	200g	P100 (=100%)	10 - 12	
Carrots	200g	P100 (=100%)	6 - 8	
Brussel sprouts	250g	P100 (=100%)	6 - 8	
Spinach	150g	P100 (=100%)+ P 30 (= 30%)	3 - 4 20 - 22	
Deserts				
Pudding/Flummery	500g	P100 (=100%)	6 - 8	

CLEANING YOUR MICROWAVE OVEN

1. Turn off the oven and remove the power plug from the wall socket before cleaning.
2. Keep the inside of the oven clean. When food splatters or spilled liquids adhere to oven walls, wipe with a damp cloth. Mild detergent may be used if the oven gets very dirty. Avoid the use of spray and other harsh cleaners as they may stain, streak or dull the door surface.
3. The outside surfaces should be cleaned with a damp cloth. To prevent damage to the operating parts inside the oven, water should not be allowed to seep into the ventilation openings.
4. Wipe the door and window on both sides, the door seals and adjacent parts frequently with a damp cloth to remove any spills or splatters. Do not use abrasive cleaner.
5. Do not allow the control panel to become wet. Clean with a soft, damp cloth. When cleaning the control panel, leave oven door open to prevent oven from accidentally turning on.
6. If steam accumulates inside or around the outside of the oven door, wipe with a soft cloth. This may occur when the microwave oven is operated under high humidity condition. And it is normal.
7. It is occasionally necessary to remove the glass tray for cleaning. Wash the tray in warm sudsy water or in a dishwasher.
8. The roller ring and oven floor should be cleaned regularly to avoid excessive noise. Simply wipe the bottom surface of the oven with mild detergent. The roller ring may be washed in mild sudsy water or dishwasher. When

For Customer Services & Spare Parts please call **0845 209 7461** Opening times: Monday – Friday 8am – 6pm

removing the roller ring from cavity floor for cleaning, be sure to replace in the proper position.

9. Remove odors from your oven by combining a cup of water with the juice and skin of one lemon in a deep microwaveable bowl, microwave for 5 minutes. Wipe thoroughly and dry with a soft cloth.
10. When it becomes necessary to replace the oven light, please consult a dealer to have it replaced.
11. The oven should be cleaned regularly and any food deposits removed. Failure to maintain the oven in a clean condition could lead to deterioration of the surface that could adversely affect the life of the appliance and possibly result in a hazardous situation.
12. Please do not dispose this appliance into the domestic rubbish bin, it should be disposed to the particular disposal center provided by the municipalities.

Removable Parts

1. The turntable may be cleaned at the sink. Be careful not to chip or scratch the edges as this may cause the turntable to break during use.
2. The turntable roller rest should be cleaned regularly.
3. Do not immerse the turntable glass in cold water.

Special Care

For best performance and safety, the inner door panel and the oven front frame should be free of food residue. To prevent damage to the operating parts inside the oven, water should not be allowed to seep into the ventilation openings.

TROUBLESHOOTING AND MAINTENANCE

NORMAL CONDITION

Microwave oven interfering with TV reception.

Radio and TV reception may be interfered with when microwave oven is in operation. It is similar to the interference of small electrical appliances such as food mixers, vacuum cleaners and electric fans. This is normal.

Oven light dim.

In low power microwave cooking, oven light may become dim. This is normal.

Steam accumulating on door, hot air out of vents.

In cooking, steam may come out of food. Most will come out from vents but some may condense on cool places such as the oven door. This is normal.

Oven started accidentally with no food in.

Although starting the oven with no food in it should be avoided, it does no damage to the oven provided it is only operated empty for a very short time. It is advised that a glass or microwave safe container of water is always left in the oven to absorb any heat should the oven be turned on accidentally.

MAINTENANCE

Troubleshooting

Check for problems by using the chart below. If the microwave oven still does not work properly, contact the nearest authorised service centre.

PROBLEM	POSSIBLE CAUSE
Oven will not start	a. Plug not secure in power socket, or not switched on. b. Door is open. c. Wrong operation is set.
Arcing or sparking	a. Materials which should be avoided in microwave oven are used. b. The oven is operated when empty. c. Spilled food remains in the cavity.
Unevenly cooked food	a. Materials which should be avoided in microwave oven are used. b. Food is not defrosted completely. c. Power setting for cooking time is incorrect. d. Food is not turned or stirred.
Overcooked food	Power setting for cooking time is incorrect.
Undercooked food	a. Materials to be avoided in microwave oven are used. b. Food is not defrosted completely. c. Oven ventilation ports are restricted. d. Power setting for cooking time is incorrect.
Incomplete defrosting	a. Materials to be avoided in microwave oven are used. b. Power setting for cooking time is incorrect. c. Food is not turned or stirred.
Noise comes from turntable when oven is turned on	Food residue exists between the turntable roller rest and cavity bottom.
Oven light does not glow	a. The light bulb has burned out b. START has not been pressed.

QUESTIONS AND ANSWERS

Q: When the oven is plugged into a wall outlet for the first time, it does not work properly. What's wrong?

A: The microcomputer used in the oven control may temporarily become scrambled and fail to function as programmed. Unplug the oven from the wall outlet and then plug it back in. The microcomputer will then reset for proper functioning.

Q: Why is there noise coming from the oven when using a lower power level?

A: When cooking with power other than 100%, the oven automatically switches on and off to obtain the correct power output. The clicking noise can be heard when the oven switches on and off. This is normal

Q: Why is there steam coming out of the air exhaust vent?

A: Steam is produced during cooking. The microwave oven has been made to vent this steam.

Q: What is wrong when the oven light will not glow?

A: There may be several reasons why the oven light will not glow. The light bulb has burned out or START has not been pressed.

Q: Why do eggs sometimes burst?

A: The egg yolk may burst because of steam build-up inside the membrane. Pierce the membrane with a toothpick before

cooking it. Never microwave eggs in the shell as they may explode.

Q: How is boiling over avoided?

A: Use a larger utensil than usual for cooking. If you open the oven door or touch STOP/CLEAR, the food will stop boiling.

IMPORTANT NOTES

1. Before first using this oven please read this instruction manual and keep it for future reference.
2. Do not attempt to repair the oven yourself, please consult an authorised service agent.
3. The contents of feeding bottles and baby food jars are to be stirred or shaken and the temperature should be carefully checked before consumption, in order to avoid burns.
4. Check the oven and the cable regularly for damage. If there is any kind of damage, the oven should not be used.

Warning:

- a. It is hazardous for anyone other than a trained person to carry out any service or repair operation which involves the removal of any cover which gives protection against exposure to microwave energy.
- b. Never allow children to use the oven without supervision unless adequate instructions have been given so that the children are able to use the oven in a safe way and understand the hazards of improper use.
- c. If the supply cord is damaged, it must be replaced by the manufacturer or its service agent or a similarly qualified person in order to avoid a hazard.

NOTE

- Do not attempt to operate this oven with the door open since open-door operation can result in harmful exposure to microwave energy. It is important not to try and override or tamper with the safety interlocks.
- Carefully clean door seals and sealing surfaces.
- Do not operate the oven if it is damaged. It is particularly important that the oven door closes properly and that there is no damage to the, (1) door (i.e. door is not bent or dented), (2) hinges and latches (broken or loosened), (3) door seals and sealing surfaces.
- Utensils should be checked to ensure that they are suitable for use in microwave ovens.
- When heating food in plastic or paper containers, check the oven frequently to avoid any possibility of ignition.
- Microwave heating of beverages can result in delayed eruptive boiling, therefore care has to be taken when handling the container.
- If smoke is observed, switch off or unplug the appliance immediately and keep the door closed in order to stifle any flames.
- Eggs in their shells and whole hard-boiled eggs should not be heated in microwave ovens since they may explode.
- If the door or door seals are damaged the oven must not be operated until it has been repaired by a trained person.
- Liquids or other foods must not be heated in sealed containers since they are liable to explode.

Bulb replacement

If the interior light bulb fails, it can be easily replaced by a qualified service engineer. Do not attempt to remove the outer casing as this will expose live components. Please consult a qualified service engineer.

EARTHING INSTALLATION

DANGER

Electric Shock Hazard
Touching some of the internal components can cause serious personal injury or death. Do not disassemble this appliance.

WARNING

Electric Shock Hazard
Improper earthing can result in electric shock. Do not plug into an outlet until appliance is properly installed and earthed.
Three pin earthed plug
Properly polarised and earthed outlet.

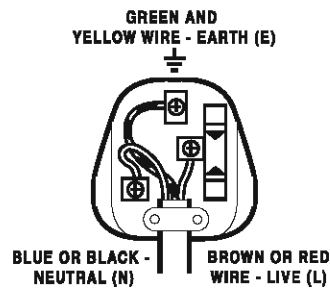

DANGER
Electric Shock Risk

This appliance must be earthed. In the event of an electrical short circuit, grounding reduces the risk of electric shock by providing an escape wire for the electric current. This appliance is equipped with a cord having a grounding wire with an earthing plug. The plug must be plugged into an outlet that is properly installed and earthed.

Consult a qualified electrician or serviceman if the earthing instructions are not completely understood or if doubt exists as to whether the appliance is properly earthed. If it is necessary to use an extension cord, use only a 3-wire extension cord that has a 3 pin earthing plug, and a 3-slot socket which will accept the plug.

1. A short power-supply cord is provided to reduce the risks resulting from becoming entangled in or tripping over a longer cord.
2. If an extension cord is used:
 - a. The marked electrical rating of the extension cord should be at least as great as the electrical rating of the appliance.
 - b. The extension cord must be earthed, a 3-wire cord.
 - c. The extension cord should be arranged so that it will not drape over the worktop or tabletop where it can be pulled on by children or tripped over accidentally.

Check that the voltage marked on the product corresponds with your supply voltage.

This product is fitted with a 13 A plug complying with BS 1363. If this plug is unsuitable or needs to be replaced, please note the following:

Important: The wires in the mains lead are coloured in accordance with the following code:

GREEN / YELLOW - EARTH,

BLUE - NEUTRAL, BROWN - LIVE

For UK use only

Plug fitting details (where applicable):

As the colours of the wires in the mains lead of this appliance may not correspond with the coloured markings identifying the terminals in your plug proceed as follows:

The GREEN/YELLOW wire is the EARTH and must be connected to the terminal which is marked with the letter (E) or by the earth symbol or coloured GREEN or GREEN/YELLOW.

The BLUE wire is the NEUTRAL and must be connected to the terminal marked with the letter (N) or coloured BLACK

The BROWN wire is the LIVE and must be connected to the terminal marked with the letter (L) or coloured RED.

Always ensure that the plug cord grip is fastened correctly.

If a 13A (BS 1363) fused plug is used it must be fitted with a 13A fuse conforming to BS 1362 and be ASTA approved.

If in doubt contact a qualified electrician.

For Customer Service and
Spare Parts please call
0845 209 7461
Opening times:
Monday – Friday
8am until 6pm

Revision 1



This symbol is known as the 'Crossed-out wheeie bin Symbol'. When this symbol is marked on a product/batteries, it means that the product/batteries should not be disposed of with your general household waste. Only discard electrical/electronic/battery items in separate collection schemes, which cater for the recovery and recycling of materials contained within. Your co-operation is vital to make sure the success of these schemes and for the protection of the environment. For your nearest disposal facility, visit www.recycle-more.co.uk or ask in store for details.

We reserve the right due to possible changes to design to alter the instruction manual without prior notice.

For Customer Services & Spare Parts please call **0845 209 7461** Opening times: Monday – Friday 8am – 6pm